

## MILWAUKEE VALVE CO.

### NAVY BRONZE SWING CHECK – FLANGED ENDS

**1260-004**

**250 psi WOG**  
NI-CU Disc & Seat  
803-1385637

Mil-V-17547, Type A,  
Class 2

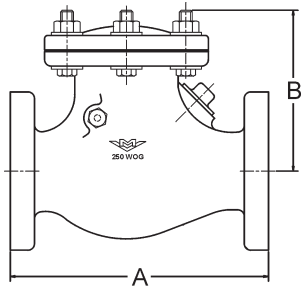

Size	A	B	C
2-1/2	10	5-5/8	6-1/8
3	10-3/4	6-9/32	6-5/8
4	12-1/4	7-5/32	7-11/16
5	13-3/4	8-21/32	9-1/16
6	15-1/4	9-7/16	10-1/8
8	18-1/2	11-11/16	12-3/8
10	21-3/4	13-19/32	15
12	25-1/4	15-25/32	17-5/8

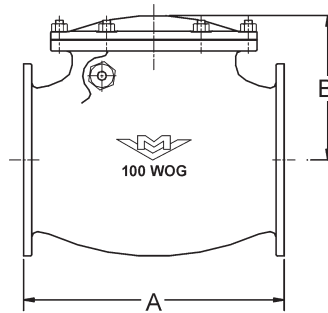

**1281-001**

**100 psi WOG**

Bronze Disc – Bolted Cap  
MIL-V-17547, Type A, Class 1

#### DIMENSIONS – INCHES

SIZE	A	B
2	7-5/16	4-1/4
2-1/2	8-5/16	4-1/4
3	9	5-1/2
3-1/2	9	5-15/16
4	11-3/4	6-9/16
5	13-1/2	7-13/16
6	15-1/2	8-7/8
8	19-1/2	11-1/16
10	22	12

### HOSE END GLOBE/ANGLE – COMMERCIAL/NAVY FLANGED

**1471 / 1474**

**ANSI Hose Globe Valve**  
**150 WOG**

Bolted Bonnet, Gland Packed  
Renewable Composition Disc

**1481** – Same as above,  
but Hose Angle Valve

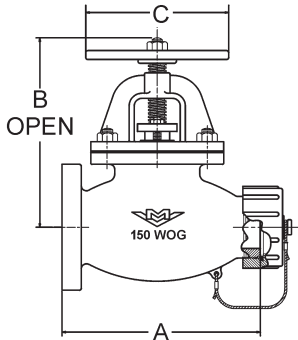

Size (in)	A	B	C
<b>1471 SERIES – COMMERCIAL</b>			
1-1/2	6-7/8	7-3/4	6
2-1/2	9-5/16	10-1/8	7
<b>1474 SERIES – NAVY</b>			
1-1/2	8-3/16	8-1/16	5
2-1/2	9-5/8	10-1/8	7

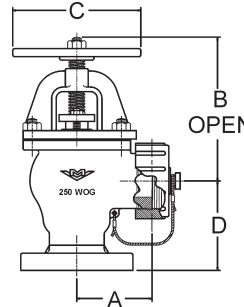

**1481 / 1484**

**Hose Angle Valve**  
**250 WOG**

Renewable Disc 2-1/2" Bolted Bonnet  
(Specify EPR or Nitrile) (NAVSEA 803-1385712)

1-1/2" Union Bonnet **1484** – Same as 1474,  
(NAVSEA 803-1385711) but Hose Angle Valve

Size (in)	A	B	C	D
<b>1481 SERIES – COMMERCIAL</b>				
1-1/2	3-1/4	7-5/16	6	3-7/16
2-1/2	4-1/8	9-1/4	7	4-3/16
<b>1484 SERIES – NAVY</b>				
1-1/2	2-5/8	7-1/4	5	3-3/4
2-1/2	4-1/8	8-3/4	7	4-7/8

### MARINE BRONZE GLOBE – SILBRAZED UNION ENDS

**161 SERIES**

**200 psi SWP @ 425°F**

**400 psi WOG @ 150°F**

Union Bonnet, Gland Packed  
Renewable Disc & Seat Ring  
Specify E.P.R. or Nitrile "O" Ring  
NAVSEA 803-4384536 – Type 1

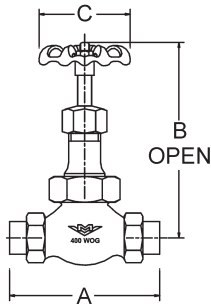

Optional Models:  
Soft Seat 161B  
Stop Check 162A  
Needle 165A

DIMENSIONS – INCHES			
SIZE	A	B	C
1/4	4	4-3/8	2
3/8	4-3/8	4-11/32	2-1/2
1/2	5-1/8	5-3/16	2-3/4
3/4	5-3/4	6-1/16	3
1	6-3/8	6-7/8	3-1/2
1-1/4	7-3/8	7-11/16	4
1-1/2	8-1/4	8-3/8	4-3/4
2	9-5/8	10-7/16	5-1/4

### MARINE BRONZE ANGLE – SILBRAZED UNION ENDS

**163 SERIES**

**200 psi SWP @ 425°F**

**400 psi WOG @ 150°F**

Union Bonnet, Gland Packed  
Renewable Disc and Seat Ring  
Specify E.P.R. or Nitrile "O" Ring  
NAVSEA 803-4384536 – Type 3

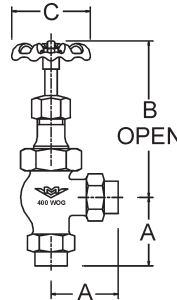

Optional Models:  
Soft Seat 163B  
Stop Check 164A  
Needle 168A

DIMENSIONS – INCHES			
SIZE	A	B	C
1/4	2	4-3/8	2
3/8	2-1/4	4-11/32	2-1/2
1/2	2-7/16	5-3/16	2-3/4
3/4	2-7/8	6-1/16	3
1	3-1/4	6-7/8	3-1/2
1-1/4	3-3/4	7-11/16	4
1-1/2	4-1/16	8-3/8	4-3/4
2	4-11/16	10-7/16	5-1/4

### MARINE BRONZE SWING CHECK – SILBRAZED UNION ENDS

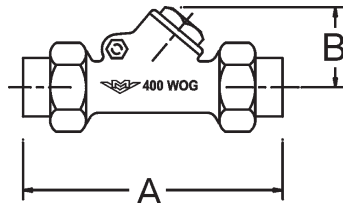

**5399 SERIES**

**400 psi WOG @ 150°F**

Regrinding NI-CU Disc  
Threaded Cap  
Specify E.P.R. or Nitrile "O" Ring  
NAVSEA 803-1385721

DIMENSIONS – INCHES		
SIZE	A	B
1/4	4-7/16	1-9/16
3/8	5-1/8	1-3/4
1/2	5-3/4	1-3/4
3/4	6-9/16	2
1	7-1/4	2-7/16
1-1/4	8-5/16	2-7/8
1-1/2	9-1/8	3-1/4
2	10-13/32	3-15/16

### MARINE BRONZE GATE – SILBRAZED UNION ENDS

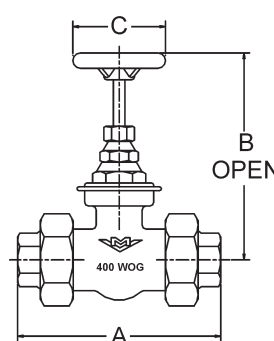

**1146 SERIES**

**400 psi WOG @ 150°F**

Non-rising Stem, Solid Wedge  
Threaded Bonnet, Gland Packed  
Specify E.P.R. or Nitrile "O" Ring

DIMENSIONS – INCHES			
SIZE	A	B	C
1/4	3-5/8	3-15/16	2-1/8
3/8	4-1/4	3-15/16	2-1/8
1/2	4-7/8	4-3/8	2-3/4
3/4	5-1/2	4-3/4	2-3/4
1	6-1/16	5-1/8	3
1-1/4	7-1/16	6-1/16	3-3/4
1-1/2	7-5/8	6-3/4	4
2	8-3/4	8	5

See our ad on  
page 1236 for  
**ANSI Flange gate,  
globe, check, and  
hose valves.**



**MILWAUKEE VALVE**

TEL: 262-432-2700 • FAX: 262-432-2804

E-Mail: [info@milwaukeevalve.com](mailto:info@milwaukeevalve.com) • WEB: [www.milwaukeevalve.com](http://www.milwaukeevalve.com)

Please consult  
factory for the  
closest dealer  
or to order a  
full-line catalog.